

Representation of the outer dimensions (See the details in visualization)

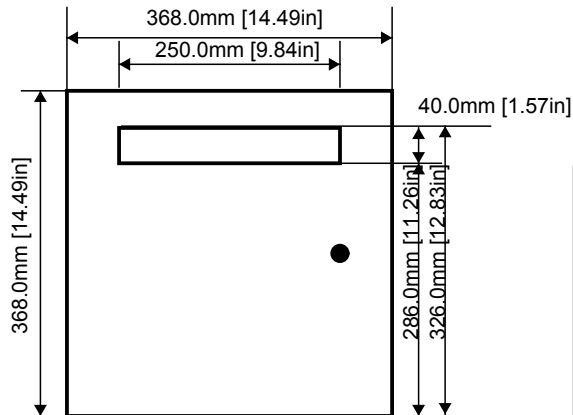
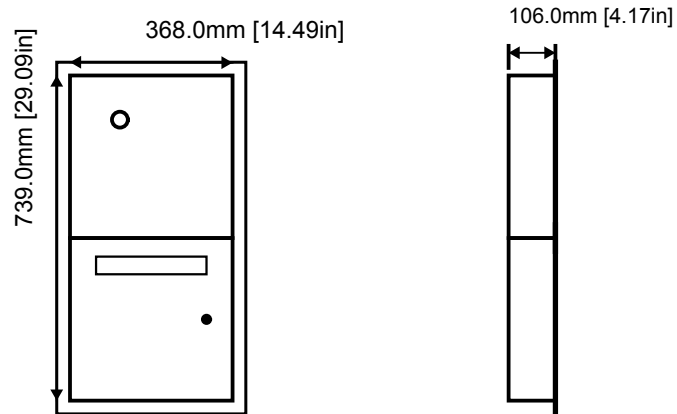

Technical data:

1 x Nameplate configuration DBI-62751040
1 x flush-mounted letterbox with covers
Letterbox flap without nameplate. Flush with front panel.

Stainless steel V4A (salt-water resistant), brushed

This system is an individual production according to customer specifications. The legal right of withdrawal therefore does not exist according to § 312 g Abs. 2 Nr. 1 BGB. Since the automated production process is started immediately after receipt of the order, a cancellation, a return or exchange after placing the order is not possible.

Date: 2024-02-22
Time: 01:42:30 CET
Project ID: DBL-79529886



Bird Home Automation GmbH
Uhlandstraße 165
D-10719 Berlin, Germany
Confidential